

## SMCJ160CA TVS Diodes SOCAY SMCJ ESD Suppressors Surface Mount

Our Product Introduction

### Basic Information

- Place of Origin: Shenzhen, Guangdong, China
- Brand Name: SOCAY
- Certification: UL, REACH, RoHS, ISO
- Model Number: SMCJ160CA
- Minimum Order Quantity: 3000PCS
- Price: Negotiable
- Packaging Details: tape reel
- Delivery Time: 5-8 work days
- Supply Ability: 10000000pcs



### Product Specification

- Name: TVS Diodes
- SMCJ160CA Package Type: DO-214AB/SMC
- Vrwm: 160V
- Vbr@It (Min.): 178V
- Vbr@It (Max.): 197V
- Product It: 1mA
- Vc@Ipp: 259V
- SMCJ160CA Storage Temperature Range: -55 To +150
- Highlight: **SMCJ160CA TVS Diodes, SMCJ TVS Diodes, ESD Suppressors**

for more products please visit us on [socaydiode.com](http://socaydiode.com)

## Product Description

### SMCJ160CA TVS Diodes SCOAY SMCJ ESD Suppressors Surface Mount

**SMCJ160CA TVS Diodes DATASHEET: [SMCJ\\_v2107.1 .pdf](#)**

#### SMCJ160CA TVS Diode Illustration:

SMCJ160CA TVS Diode is used in Telecom, Computer, Industrial and Consumer electronic applications, is ideal for the protection of I/O interfaces,  $V_{CC}$  bus and other vulnerable circuits. The SMCJ160CA TVS Diode is designed specifically to protect sensitive electronic equipment from voltage transients induced by lightning and other transient voltage events.

#### SMCJ160CA TVS Diode Features:

TVS Diode is For surface mounted applications in order to optimize board space

SMCJ160CA has Low leakage

This TVS Diode is a Bidirectional unit

SMCJ160CA TVS Diode is Glass passivated junction

TVS Diode has Low inductance

SMCJ160CA TVS Diode has Excellent clamping capability

SMCJ160CA TVS Diode 's Peak power capability at  $10 \times 1000\mu s$  waveform Repetition rate (duty cycle):0.01% is 1500W

Its Fast response time: typically less than 1.0ps from 0 Volts to VBR min

SOCAY TVS Diode 's Typical IR less than  $5\mu A$  above 12V.

High Temperature soldering:  $260^{\circ}C/40$  seconds at terminals

SMCJ160CA TVS Diode 's Typical maximum temperature coefficient  $\Delta VBR = 0.1\% \times VBR@25^{\circ}C \times \Delta T$

Plastic package has Underwriters Laboratory Flammability 94V-0

Matte tin lead-free Plated

SMCJ160CA TVS Diode has Halogen free and RoHS compliant

Typical failure mode is short from over-specified voltage or current

Whisker test is conducted based on JEDEC JESD201A per its table 4a and 4c

IEC-61000-4-2 ESD 15kV(Air), 8kV (Contact)

SOCAY SMD TVS' ESD protection of data lines in accordance with IEC 61000-4-2 (IEC801-2)

EFT protection of data lines in accordance with IEC 61000-4-4 (IEC801-4)

Product Part Number		SMCJ160CA TVS Marking		TVS Reverse Stand-Off Voltage VRWM (V)	TVS Breakdown Voltage VBR (V) @IT		TVS Test Current IT (mA)	TVS Maximum Clamping Voltage VC @IPP (V)	TVS Maximum Peak Pulse Current IPP (A)	SMD TVS Maximum Reverse Leakage IR @VRWM ( $\mu A$ )
Uni	Bi	Uni	Bi		MIN	MAX				
SMCJ160A	SMCJ160CA	GHP	BHP	160.0	178.00	197.00	1	259.0	5.79	5

Electrical Characteristics (T<sub>A</sub>=25°C unless otherwise noted)

Part Number		Marking		Reverse Stand-Off Voltage V <sub>RRM</sub> (V)	Breakdown Voltage V <sub>BR</sub> (V) @I <sub>r</sub>		Test Current I <sub>r</sub> (mA)	Maximum Clamping Voltage V <sub>C</sub> @I <sub>tr</sub> (V)	Maximum Peak Pulse Current I <sub>tr</sub> (A)	Maximum Reverse Leakage I <sub>r</sub> @V <sub>RRM</sub> (μA)
Uni	Bi	Uni	Bi		MIN	MAX				
SMCJ5.0A	SMCJ5.0CA	GDE	BDE	5.0	6.40	7.00	10	9.2	163.04	1000
SMCJ6.0A	SMCJ6.0CA	GDG	BDG	6.0	6.67	7.37	10	10.3	145.63	1000
SMCJ6.5A	SMCJ6.5CA	GDK	BDK	6.5	7.22	7.98	10	11.2	133.93	500
SMCJ7.0A	SMCJ7.0CA	GDM	BDM	7.0	7.78	8.60	10	12.0	125.00	200
SMCJ7.5A	SMCJ7.5CA	GDP	BDP	7.5	8.33	9.21	1	12.9	116.28	100
SMCJ8.0A	SMCJ8.0CA	GDR	BDR	8.0	8.89	9.83	1	13.6	110.29	50
SMCJ8.5A	SMCJ8.5CA	GDT	BDT	8.5	9.44	10.40	1	14.4	104.17	20
SMCJ9.0A	SMCJ9.0CA	GDV	BDV	9.0	10.00	11.10	1	15.4	97.40	10
SMCJ10A	SMCJ10CA	GDX	BDX	10.0	11.10	12.30	1	17.0	88.24	5
SMCJ11A	SMCJ11CA	GDZ	BDZ	11.0	12.20	13.50	1	18.2	82.42	5
SMCJ12A	SMCJ12CA	GEE	BEE	12.0	13.30	14.70	1	19.9	75.38	5
SMCJ13A	SMCJ13CA	GEG	BEG	13.0	14.40	15.90	1	21.5	69.77	5
SMCJ14A	SMCJ14CA	GEK	BEK	14.0	15.60	17.20	1	23.2	64.66	5
SMCJ15A	SMCJ15CA	GEM	BEM	15.0	16.70	18.50	1	24.4	61.48	5
SMCJ16A	SMCJ16CA	GEP	BEP	16.0	17.80	19.70	1	26.0	57.69	5
SMCJ17A	SMCJ17CA	GER	BER	17.0	18.90	20.90	1	27.6	54.35	5
SMCJ18A	SMCJ18CA	GET	BET	18.0	20.00	22.10	1	29.2	51.37	5
SMCJ19A	SMCJ19CA	GEB	BEB	19.0	21.10	23.30	1	30.8	48.73	5
SMCJ20A	SMCJ20CA	GEV	BEV	20.0	22.20	24.50	1	32.4	46.30	5
SMCJ22A	SMCJ22CA	GEX	BEX	22.0	24.40	26.90	1	35.5	42.25	5
SMCJ24A	SMCJ24CA	GEZ	BEZ	24.0	26.70	29.50	1	38.9	38.56	5
SMCJ26A	SMCJ26CA	GFE	BFE	26.0	28.90	31.90	1	42.1	36.63	5
SMCJ28A	SMCJ28CA	GFG	BFG	28.0	31.10	34.40	1	45.4	33.04	5
SMCJ30A	SMCJ30CA	GFK	BFK	30.0	33.30	36.80	1	48.4	30.99	5
SMCJ33A	SMCJ33CA	GFM	BFM	33.0	36.70	40.60	1	53.3	28.14	5
SMCJ36A	SMCJ36CA	GFP	BFP	36.0	40.00	44.20	1	58.1	25.82	5
SMCJ40A	SMCJ40CA	GFR	BFR	40.0	44.40	49.10	1	64.5	23.26	5
SMCJ43A	SMCJ43CA	GFT	BFT	43.0	47.80	52.80	1	69.4	21.61	5

Part Number		Marking		Reverse Stand-Off Voltage V <sub>RRM</sub> (V)	Breakdown Voltage V <sub>BR</sub> (V) @I <sub>r</sub>		Test Current I <sub>r</sub> (mA)	Maximum Clamping Voltage V <sub>C</sub> @I <sub>tr</sub> (V)	Maximum Peak Pulse Current I <sub>tr</sub> (A)	Maximum Reverse Leakage I <sub>r</sub> @V <sub>RRM</sub> (μA)
Uni	Bi	Uni	Bi		MIN	MAX				
SMCJ45A	SMCJ45CA	GFV	BFV	45.0	50.00	55.30	1	72.7	20.63	5
SMCJ48A	SMCJ48CA	GFX	BFX	48.0	53.30	58.90	1	77.4	19.38	5
SMCJ51A	SMCJ51CA	GFZ	BFZ	51.0	56.70	62.70	1	82.4	18.20	5
SMCJ54A	SMCJ54CA	GGE	BGE	54.0	60.00	66.30	1	87.1	17.22	5
SMCJ58A	SMCJ58CA	GGG	BGG	58.0	64.40	71.20	1	93.6	16.03	5
SMCJ60A	SMCJ60CA	G GK	B GK	60.0	66.70	73.70	1	96.8	15.50	5
SMCJ64A	SMCJ64CA	GGM	BGM	64.0	71.10	78.60	1	103.0	14.56	5
SMCJ70A	SMCJ70CA	GGP	BGP	70.0	77.80	86.00	1	113.0	13.27	5
SMCJ75A	SMCJ75CA	GGR	BGR	75.0	83.30	92.10	1	121.0	12.40	5
SMCJ78A	SMCJ78CA	GGT	BGT	78.0	86.70	95.80	1	126.0	11.90	5
SMCJ80A	SMCJ80CA	GGB	BGB	80.0	88.80	97.60	1	129.6	11.57	5
SMCJ85A	SMCJ85CA	GGV	BGV	85.0	94.40	104.00	1	137.0	10.95	5
SMCJ90A	SMCJ90CA	GGX	BGX	90.0	100.00	111.00	1	146.0	10.27	5
SMCJ100A	SMCJ100CA	GGZ	BGZ	100.0	111.00	123.00	1	162.0	9.26	5
SMCJ110A	SMCJ110CA	GHE	BHE	110.0	122.00	135.00	1	177.0	8.47	5
SMCJ120A	SMCJ120CA	GHG	BHG	120.0	133.00	147.00	1	193.0	7.77	5
SMCJ130A	SMCJ130CA	GHK	BHK	130.0	144.00	159.00	1	209.0	7.18	5
SMCJ140A	SMCJ140CA	GHB	BHB	140.0	155.00	171.00	1	226.8	6.61	5
SMCJ150A	SMCJ150CA	GHM	BHM	150.0	167.00	185.00	1	243.0	6.17	5
SMCJ160A	SMCJ160CA	GHP	BHP	160.0	178.00	197.00	1	259.0	5.79	5
SMCJ170A	SMCJ170CA	GHR	BHR	170.0	189.00	209.00	1	275.0	5.45	5
SMCJ180A	SMCJ180CA	GHT	BHT	180.0	201.00	220.00	1	291.6	5.14	5
SMCJ190A	SMCJ190CA	GHV	BHV	190.0	211.00	232.00	1	307.8	4.87	5
SMCJ200A	SMCJ200CA	GHW	BHW	200.0	224.00	247.00	1	324.0	4.60	5
SMCJ220A	SMCJ220CA	GHX	BHX	220.0	246.00	272.00	1	356.0	4.20	5
SMCJ250A	SMCJ250CA	GHZ	BHZ	250.0	279.00	309.00	1	405.0	3.70	5
SMCJ300A	SMCJ300CA	GJE	BJE	300.0	335.00	371.00	1	486.0	3.10	5
SMCJ350A	SMCJ350CA	GJG	BJG	350.0	391.00	432.00	1	567.0	2.60	5
SMCJ400A	SMCJ400CA	GJK	BJK	400.0	447.00	494.00	1	648.0	2.30	5
SMCJ440A	SMCJ440CA	GJM	BJM	440.0	492.00	543.00	1	713.0	2.10	5

Note:

- Suffix 'A' denotes 5% tolerance device.
- Add suffix 'CA' after part number to specify Bi-Directional devices.
- For Bi-Directional devices having V<sub>BR</sub> of 10 volts and under, the I<sub>r</sub> limit is double.

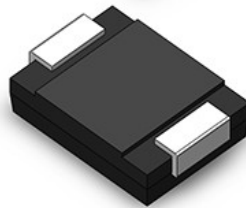
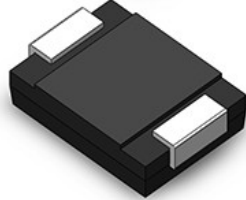

## Description

The SMCJ series is designed specifically to protect sensitive electronic equipment from voltage transients induced by lightning and other transient voltage events.

## Features

- ◆ For surface mounted applications in order to optimize board space
- ◆ Low leakage
- ◆ Uni and Bidirectional unit
- ◆ Glass passivated junction
- ◆ Low inductance
- ◆ Excellent clamping capability
- ◆ 1500W Peak power capability at 10 × 1000µs waveform Repetition rate (duty cycle):0.01%
- ◆ Fast response time: typically less than 1.0ps from 0 Volts to  $V_{BR}$  min
- ◆ Typical  $I_R$  less than 5µA above 12V.
- ◆ High Temperature soldering: 260°C/40 seconds at terminals
- ◆ Typical maximum temperature coefficient  $\Delta V_{BR} = 0.1\% \times V_{BR}@25^\circ C \times \Delta T$
- ◆ Plastic package has Underwriters Laboratory Flammability 94V-0
- ◆ Matte tin lead-free Plated
- ◆ Halogen free and RoHS compliant
- ◆ Typical failure mode is short from over-specified voltage or current
- ◆ Whisker test is conducted based on JEDEC JESD201A per its table 4a and 4c
- ◆ IEC-61000-4-2 ESD 15kV(Air), 8kV (Contact)
- ◆ ESD protection of data lines in accordance with IEC 61000-4-2 (IEC801-2)
- ◆ EFT protection of data lines in accordance with IEC 61000-4-4 (IEC801-4)

## Applications

TVS devices are ideal for the protection of I/O interfaces,  $V_{CC}$  bus and other vulnerable circuits used in Telecom, Computer, Industrial and Consumer electronic applications .

## Functional Diagram

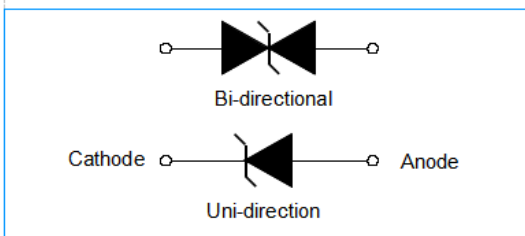

## Maximum Ratings ( $T_A=25^\circ C$ unless otherwise noted)

Parameter	Symbol	Value	Unit
Peak Pulse Power Dissipation with a 10/1000µs waveform (Fig.1)(Note 1), (Note 2)	$P_{PPM}$	1500	Watts
Peak Pulse Current with a 10/1000µs waveform (Note1, Fig.3)	$I_{PP}$	See Next Table	Amps
Power Dissipation on Infinite Heat Sink at $T_c=75^\circ C$	$P_{MAV}$	6.5	Watt
Peak Forward Surge Current, 8.3ms Single Half Sine Wave (Note 3)	$I_{FSM}$	200	Amps
Maximum Instantaneous Forward Voltage at 25A for Unidirectional Only (Note 4)	$V_F$	3.5/5.0	Voltage
Operating junction and Storage Temperature Range.	$T_J, T_{STG}$	-55 to +150	$^\circ C$

### Notes:

1. Non-repetitive current pulse, per Fig. 3 and derated above  $T_A = 25^\circ C$  per Fig. 2.
2. Mounted on 5.0mmx 5.0mm (0.03mmthick) Copper Pads to each terminal.
3. 8.3ms single half sine-wave, or equivalent square wave, Duty cycle = 4 pulses per minutes maximum.
4.  $V_F < 3.5V$  for  $V_{BR} < 200V$  and  $V_F < 6.5V$  for  $V_{BR} > 201V$ .

Figure 1 - Peak Pulse Power Rating Curve

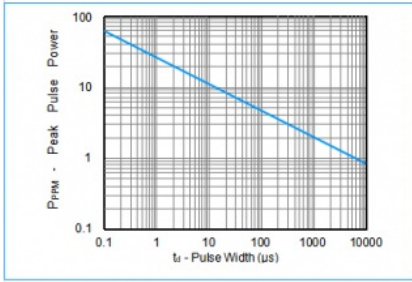

Figure 2 - Pulse Derating Curve

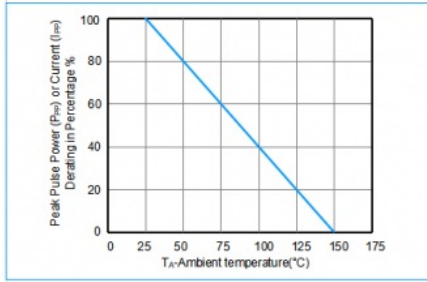

Figure 3 - Pulse Waveform

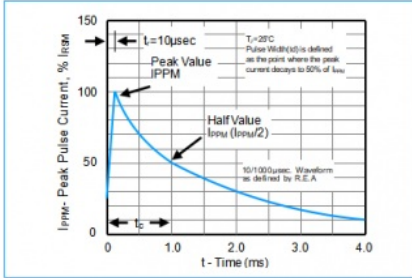

Figure 4 - Typical Junction Capacitance

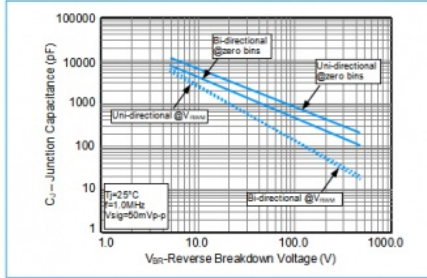

Figure 5 - Steady State Power Derating Curve

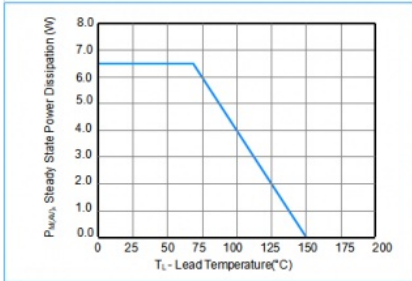
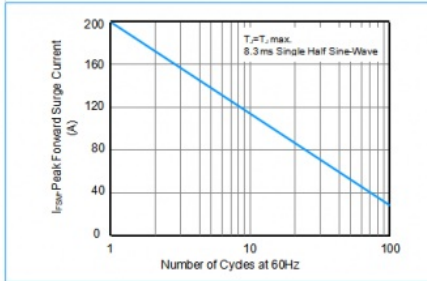
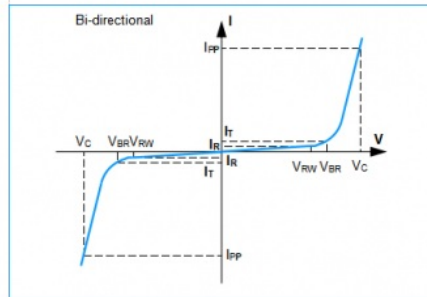
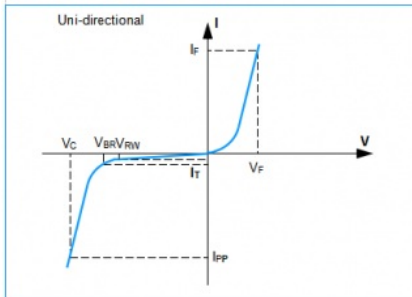

Figure 6 - Maximum Non-Repetitive Surge Current



I-V Curve Characteristics



Physical Specifications

Weight	0.007 ounce, 0.21 gram
Case	JEDEC DO-214AB Molded Plastic over glass passivated junction
Polarity	Color band denotes cathode except Bipolar
Terminal	Matte Tin-plated leads, Solderable per JESD22-B102D

Environmental Specifications

Temperature Cycle	JESD22-A104
Pressure Cooker	JESD22-A102
High Temp. Storage	JESD22-A103
HTRB	JESD22-A108
Thermal Shock	JESD22-A106

Soldering Parameters

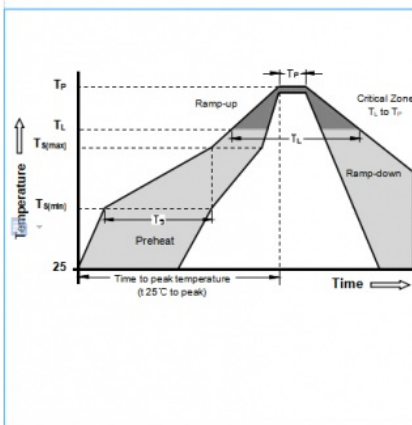

Reflow Condition	Lead-free assembly	
Pre Heat	- Temperature Min (T <sub>s(min)</sub> )	150°C
	- Temperature Max (T <sub>s(max)</sub> )	200°C
	- Time (min to max) (T <sub>s</sub> )	60 - 180 Seconds
Average ramp up rate (Liquidus Temp T <sub>L</sub> ) to peak		3°C/second max
T <sub>s(max)</sub> to T <sub>L</sub> - Ramp-up Rate		3°C/second max
Reflow	- Temperature (T <sub>L</sub> ) (Liquidus)	217°C
	- Time (min to max) (T <sub>L</sub> )	60 - 150 Seconds
Peak Temperature (T <sub>P</sub> )		260 ±0/-5°C
Time within 5°C of actual peak Temperature (t <sub>p</sub> )		20 - 40 Seconds
Ramp-down Rate		6°C/second max
Time 25°C to peak Temperature (T <sub>P</sub> )		8 minutes Max
Do not exceed		280°C

## Dimensions

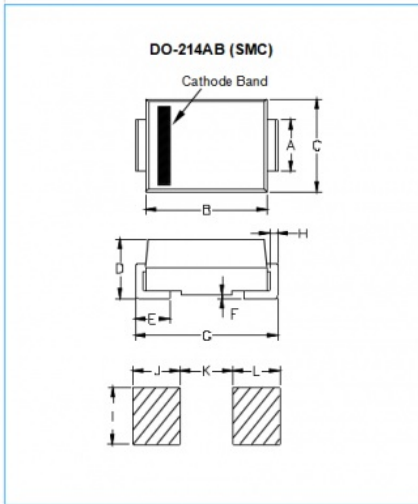

Dimensions	Inches		Millimeters	
	Min	Max	Min	Max
A	0.108	0.126	2.750	3.200
B	0.260	0.280	6.520	7.110
C	0.217	0.244	5.520	6.220
D	0.080	0.112	2.050	2.850
E	0.030	0.060	0.750	1.520
F	-	0.008	-	0.203
G	0.305	0.320	7.640	8.130
H	0.006	0.012	0.150	0.310
I	0.121	-	3.070	-
J	0.068	-	1.715	-
K	-	0.185	-	4.690
L	0.068	-	1.715	-

## Part Numbering

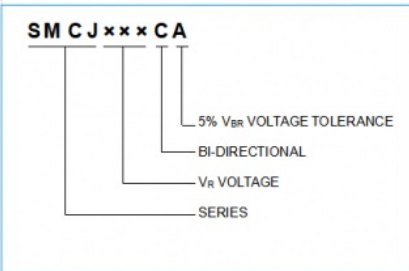

## Part Marking

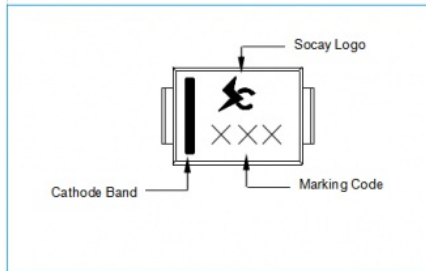

## Packaging

Part Number	Component Package	Reel (pcs)	Per Carton (pcs)	Packaging Option	Reel Diameters (mm)
SMCJXXXX	DO-214AB (SMC)	3000	48000	Tape & Reel - 20mm/13"tape	330.0

## Tape and Reel Specifications

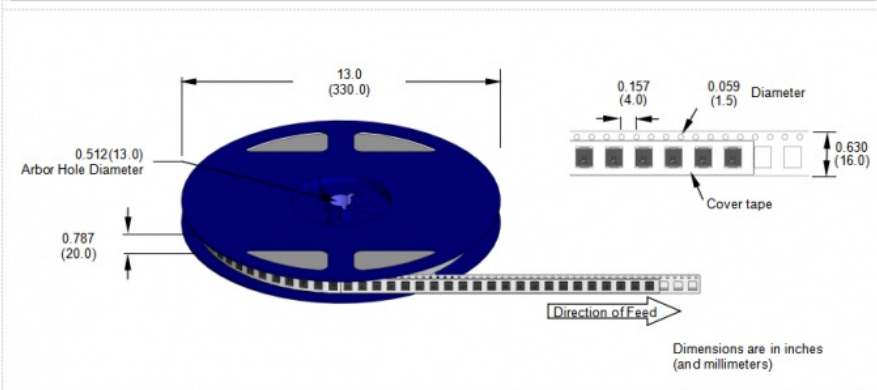

 **Shenzhen Socay Electronics Co., Ltd.**

+8618126201429

sylvia@socay.com

socaydiode.com

4/F, Block C, HeHengXing Science & Technology Park, 19 MinQing Road, LongHua District, Shenzhen City, Guangdong Province, China